

REV.	DESCRIPTION	ECN NO.	NAME	DATE
0	FIRST EDITION	N/A	Ming	2023-10-25

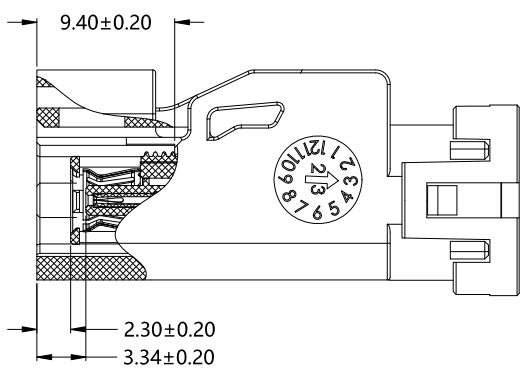

ALL PARTS MUST MEET TO RoHS REQUIREMENTS

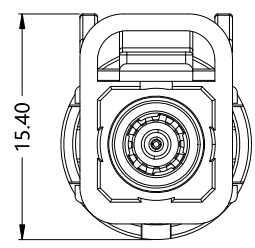
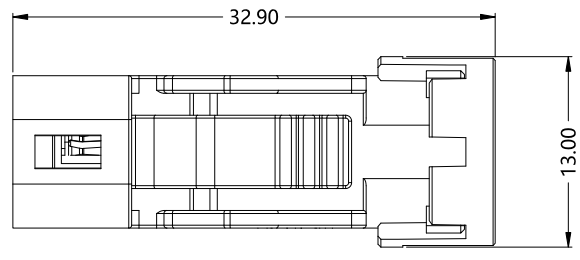
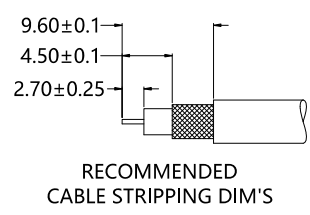

MATERIALS AND PLATING		UNIT: MICRO-INCHES
PART NAME	MATERIALS	PLATING
BODY	ZINC ALLOY	TIN PLATING THICK 100u"
INSULATOR	LCP	N/A
CONTACT PIN	COPPER ALLOY	PL.GOLD /NICKEL/COPPER
SHELL	PA	N/A
TUBE	BRASS	Nickel PLATING THICK 80u"
GASKET	HTV	N/A
CABLE TYPE: RG174		

ELECTRICAL CHARACTERISTICS	
IMPEDANCE	50 Ω
VOLTAGE RATING	250 V(rms)
FREQUENCY RANGE	DC ~ 6 GHz
DIELECTRIC WITHSTANDING VOLTAGE	>800 V
CONTACT RESISTANCE	CENTER CONTACT <5.0 mΩ
	OUTER CONTACT <2.5 mΩ
INSULATION RESISTANCE	>1000 MΩ
INSERTION LOSS	<0.15 * √ f GHz
VSWR	<1.35 @ DC~2 GHz <1.45 @ 2~4 GHz <1.55 @ 4~6 GHz
3RD INTERMODULATION	N/A

MECHANICAL CHARACTERISTICS	
MATING FORCE	≤ 25 N
DISENGAGEMENT FORCE	≥2N
CONNECTOR DISENGAGE WITH LOCK	≥110N
UNMATING FORCE WITH LOCK DISENGAGED	≤ 75 N
DURABILITY	≥100cycles

ENVIRONMENTAL PARAMETER	
TEMPERATURE RANGE	-40 °C~+105 °C
WATERTIGHTNESS	IP67















* CUSTOMER OUTLINE DRAWING

UNLESS OTHERWISE SPECIFIED:
 1) EDGES : C0.15 MAX ;
 2) REMOVE ALL BURRS ;
 3) SURFACE ROUGHNESS : Ra1.6 ;
 4) UNITS : mm ;
 5) DIMENSIONS TOLERANCES
 DECIMALS : .x ±0.3 .xx ±0.2 .xxx±0.1;
 ANGLES : ± 5°.

THIRD ANGLE PROJECTION	
APPROVED :	CUSTOMER P/N :
CHECKED :	SCALE :
DRAWING :	DATE :
PAGE : 1/2	

TITLE : FAKRA FEMALE S/T WATERPROOF FOR RG174 CABLE
 DRAWING NO. : 5FKF1*S-A02-100
 COMPANY WEBSITE : www.slkcorp.com

REV.	DESCRIPTION	ECN NO.	NAME	DATE	 ALL PARTS MUST MEET TO RoHS REQUIREMENTS
0	FIRST EDITION	N/A	Ming	2023-10-25	

Mechanical and Color Coding		
SLK P/N	Color	Coding
5FKF1AS-A02-100	Deep Black	A 
5FKF1BS-A02-100	Signal White	B 
5FKF1CS-A02-100	Signal Blue	C 
5FKF1DS-A02-100	Bordeaux Violet	D 
5FKF1ES-A02-100	Leaf Green	E 
5FKF1FS-A02-100	Brown	F 
5FKF1GS-A02-100	Blue Grey	G 
5FKF1HS-A02-100	Heather Violet	H 
5FKF1IS-A02-100	Beige	I 
5FKF1KS-A02-100	Curry Yellow	K 
5FKF1LS-A02-100	Carmin-red	L 
5FKF1MS-A02-100	Pastel orange	M 
5FKF1NS-A02-100	Pastel green	N 
5FKF1ZS-A02-100	Water Blue	Z 



MATERIALS AND PLATING		UNIT: MICRO-INCHES
PART NAME	MATERIALS	PLATING
BODY	ZINC ALLOY	TIN PLATING THICK 100u"
INSULATOR	LCP	N/A
CONTACT PIN	COPPER ALLOY	PL.GOLD /NICKEL/COPPER
SHELL	PA	N/A
TUBE	BRASS	Nickel PLATING THICK 80u"
GASKET	HTV	N/A
CABLE TYPE: RG174		

ELECTRICAL CHARACTERISTICS	
IMPEDANCE	50 Ω
VOLTAGE RATING	250 V(rms)
FREQUENCY RANGE	DC ~ 6 GHz
DIELECTRIC WITHSTANDING VOLTAGE	>800 V
CONTACT RESISTANCE	CENTER CONTACT <5.0 mΩ
	OUTER CONTACT <2.5 mΩ
INSULATION RESISTANCE	>1000 MΩ
INSERTION LOSS	<0.15 * √ f GHz
VSWR	<1.35 @ DC~2 GHz <1.45 @ 2~4 GHz <1.55 @ 4~6 GHz
3RD INTERMODULATION	N/A

MECHANICAL CHARACTERISTICS	
MATING FORCE	≤ 25 N
DISENGAGEMENT FORCE	≥2N
CONNECTOR DISENGAGE WITH LOCK	≥110N
UNMATING FORCE WITH LOCK DISENGAGED	≤ 75 N
DURABILITY	≥100cycles

ENVIRONMENTAL PARAMETER	
TEMPERATURE RANGE	-40 °C~+105 °C
WATERTIGHTNESS	IP67

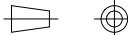
*** CUSTOMER OUTLINE DRAWING**

UNLESS OTHERWISE SPECIFIED: 1) EDGES : C0.15 MAX ; 2) REMOVE ALL BURRS ; 3) SURFACE ROUGHNESS : Ra1.6 ; 4) UNITS : mm ; 5) DIMENSIONS TOLERANCES DECIMALS : .x ±0.3 .xx ±0.2 .xxx±0.1; ANGLES : ± 5°.	THIRD ANGLE PROJECTION 	 TITLE : FAKRA FEMALE S/T WATERPROOF FOR RG174 CABLE	
	APPROVED :		CUSTOMER P/N : -
	CHECKED :	SCALE : 1 : 1	DRAWING NO. : 5FKF1*S-A02-100
	DRAWING :	DATE : 2023-10-25 PAGE : 2/2	COMPANY WEBSITE : www.slkcorp.com